

PROFİLLER

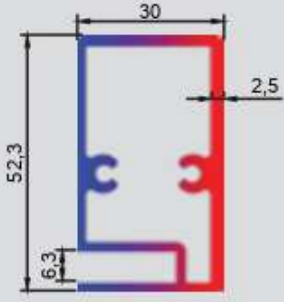

T. 2371 - 1.847 kg/m
Sabit Yatay

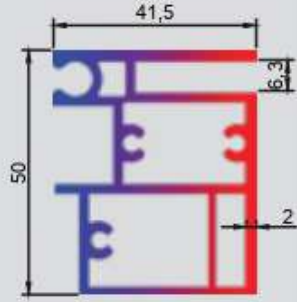

T. 2374 - 1.847 kg/m
Hareketli Dikme / Yatay

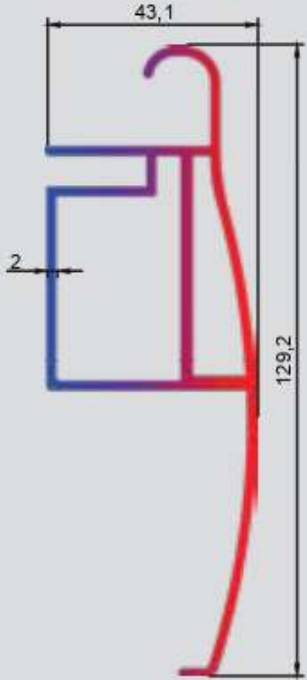

T. 2373 - 1.847 kg/m
Hareketli Küpeşte

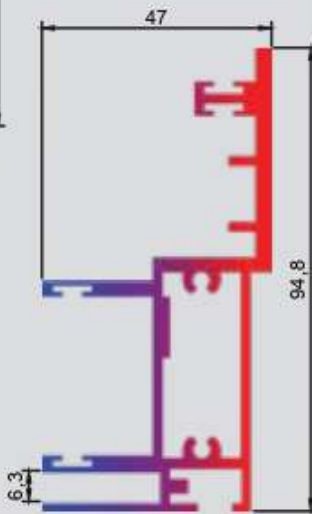

T. 2372 - 1.847 kg/m
Sabit Dikme

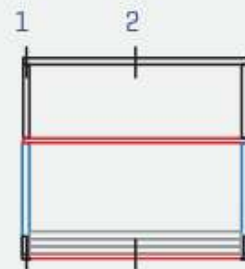
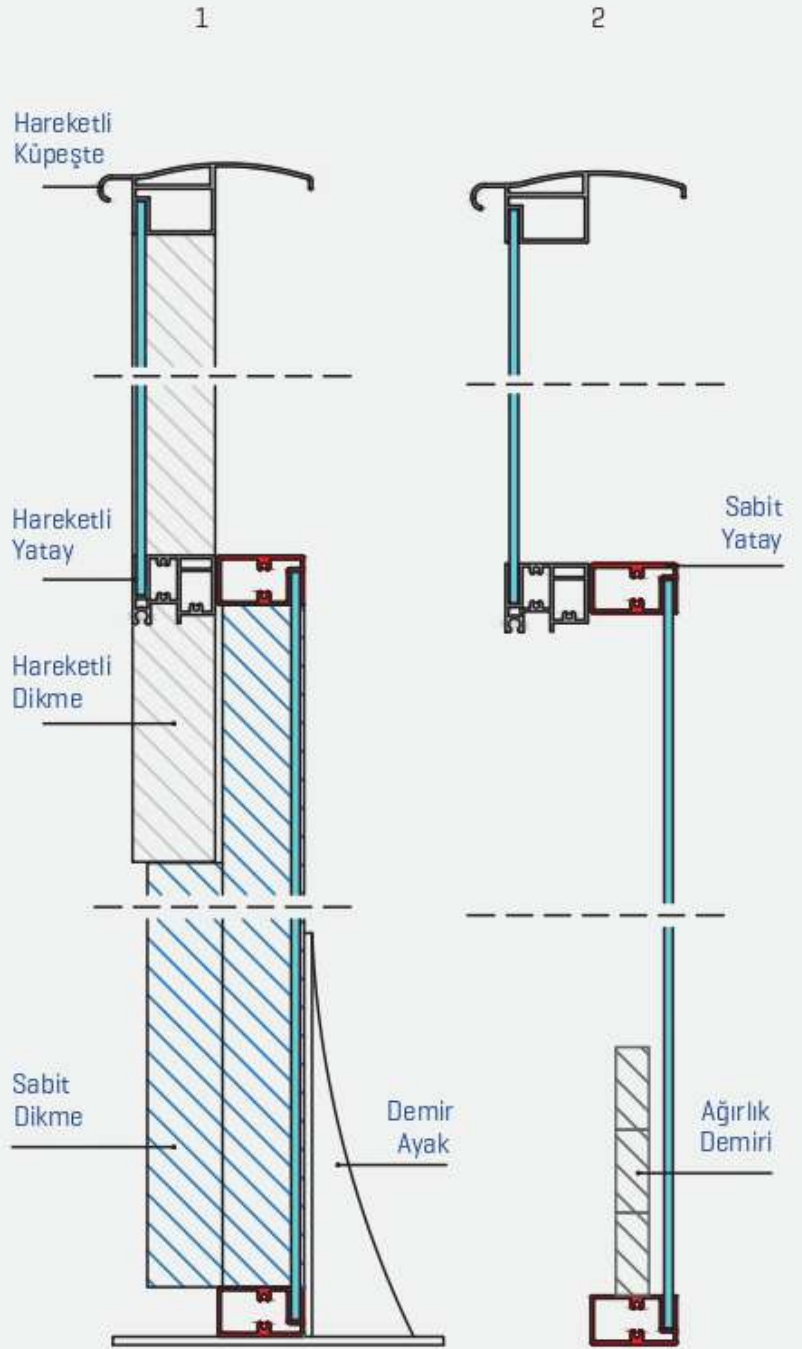

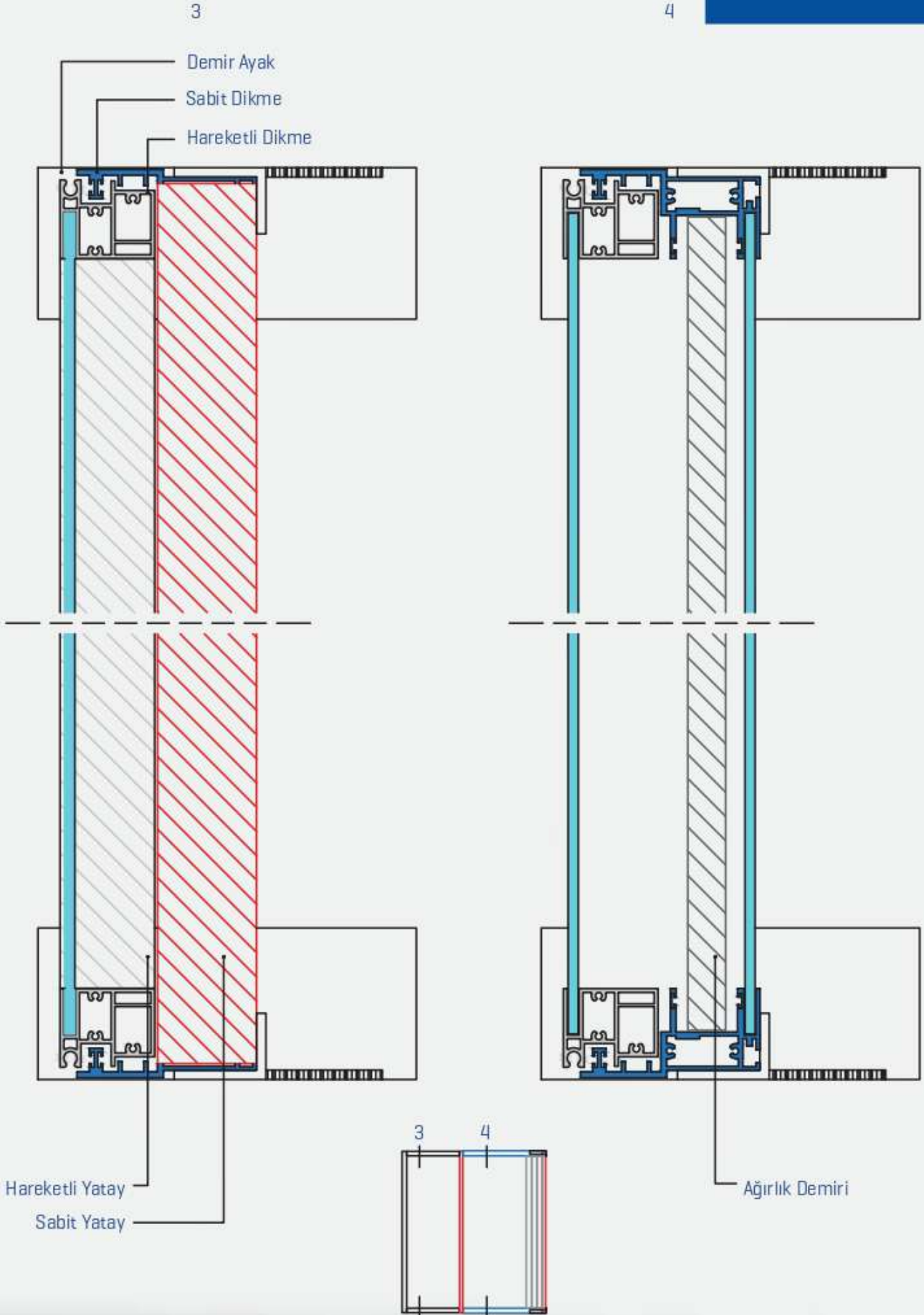

UYARI Alüminyum profillerin, yukarıda belirtilen birim ağırlıkları yaklaşık olarak hesaplanmıştır. Gerçek birim ağırlıkları, teslimat sırasında yapılan tartım işlemi sonucuna göre hesaplanacaktır.
WARNING Above mentioned aluminium profiles unit weights have been theoretically calculated. The actual unit weight will be calculated on delivery to put into the invoicing process.

AKSESUARLAR



KANAT DENGE TAKOZU



HALAT RULMANI



VİDA TAPASI



SABİT YATAY KAPAĞI



HAREKETLİ KÜPEŞTE KAPAĞI



ÇELİK HALAT



HALAT SABİTLEYİCİ



DEMİR AYAK



KANAT RULMANI